

**Mini (7/8) 3 pole, Male (Ext.) 90°/Female 90° ,**

PUR, UL/CSA, 3x16AWG, black, 5m

Male 90° – female 90°

7/8" – 7/8", 3-pole

Power cable

USA

Further cable lengths on request.

Plastic housings with good resistance against chemicals and oils.

The resistance to aggressive media should be individually tested for your application. Further details on request.

**[Link to Product](#)****Illustration**

Product may differ from Image

**Approvals**

\* only for products with UL/CSA approved cable

**Form**

Form A3A31

**General data**

Temperature range -25...+80 °C, depending on cable quality

**Cables**

Cable number	UMB
No./diameter of wires	3x 1.5 mm <sup>2</sup>
Wire isolation	TPM (br, bl, gnye)
C-track properties	5 Mio.
Jacket Color	black
Material (jacket)	PUR (UL/CSA)
Outer Ø	7.4 mm ±5%
Bend radius (fixed)	7.5x outer Ø
Bend radius (moving)	10x outer Ø
Temperature range (fixed)	-40...+80 °C
Temperature range (mobile)	-20...+80 °C

**Technical Data**

Operating voltage	max. 600 V AC/DC
Operating current per contact	max. 12 A
Locking of ports	Screw thread 7/8" (recommended torque 1.5 Nm) self-securing
Protection	IP68 inserted and tightened (EN 60529)
Compression gland	7/8" (SW24)

Locking material	Zinc die casting, matte nickel plated
Material	PUR

**Commercial data**

country of origin	DE
customs tariff number	85444290
EAN	4048879637084
eClass	27279218
Packaging unit	1

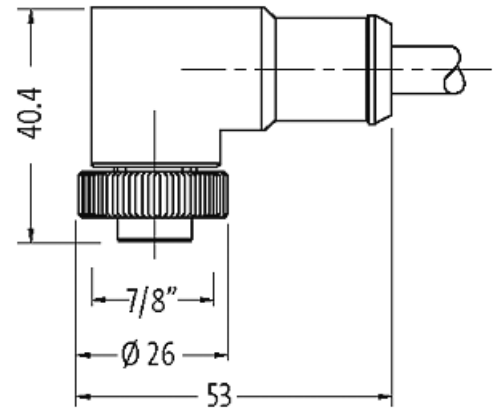
**Sketch**

Product may differ from Image